

# Accessories

## Table of Contents

<b>Hose Abrasion Sleeves, Guards, Firesleeve</b>	M-2 thru 11		
<b>Ready-Made Hose Assemblies</b>	M-12 thru 18	<b>Guardian Sleeves</b>	M-22
<b>JetCleaner, Insertion Gauge, Pressure Gauge Kit</b>	M-19	<b>Bundling Sleeves</b>	M-23
<b>Hose Spacers, Protectors</b>	M-20	<b>Bundling Straps</b>	M-24 thru 25
<b>Flaretite Seals</b>	M-21	<b>Hose and Gear Clamps</b>	M-26 thru 28



# Hose Sleeves and Guards

## Round-Wire Spring Guard

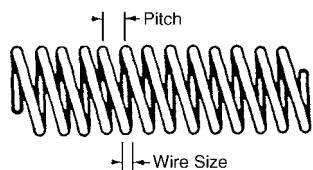

Spring guards should be considered for applications that call for tough, steel armor protection. They offer heavy-duty defense against cuts and abrasion, with the added benefit of kink resistance and the ability to mold hose assembly routing for applications requiring tight bends.

### Construction

Hot dipped Galvanized steel, chemically treated and oiled

Guard I.D.	Part Number	Package Length (ft)	Wire Diameter	Pitch
0.532	A1900	100	0.063	0.188
0.532	A1900-20	20	0.063	0.188
0.532	A1901	100	0.063	0.188
0.532	A1901-20	20	0.063	0.188
0.610	A1902	100	0.063	0.188
0.610	A1902-20	20	0.063	0.188
0.660	A1903	100	0.080	0.188
0.660	A1903-20	20	0.080	0.188
0.750	A1904	100	0.080	0.188
0.750	A1904-20	20	0.080	0.188
0.840	A1905	100	0.080	0.188
0.840	A1905-20	20	0.080	0.188
0.910	A1906	100	0.080	0.188
0.910	A1906-20	20	0.080	0.188
0.990	A1907	100	0.080	0.188
0.990	A1907-20	20	0.080	0.188
1.048	A1908	100	0.080	0.188
1.048	A1908-20	20	0.080	0.188
1.340	A1912	60	0.105	0.375
1.642	A1913	60	0.120	0.375
1.880	A1916	60	0.120	0.375
2.125	A1917	40	0.120	0.375
2.300	A1919	40	0.120	0.375

## Flat-Wire Spring Guard

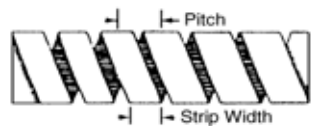

Spring guards should be considered for applications that call for tough, steel armor protection. They offer heavy-duty defense against cuts and abrasion, with the added benefit of kink resistance and the ability to mold hose assembly routing for applications requiring tight bends.

Guard I.D.	Part Number	Package Length (ft)	Strip Thickness	Strip Width	Pitch
0.500	A2900	100	0.028	0.250	0.37
0.570	A2901	100	0.028	0.250	0.37
0.625	A2902	100	0.028	0.250	0.37
0.750	A2904	100	0.028	0.250	0.37
0.875	A2905	100	0.028	0.250	0.37
0.900	A2906	100	0.028	0.500	0.69
0.990	A2907	100	0.028	0.500	0.69
1.031	A2908	100	0.028	0.500	0.69
1.110	A2909	100	0.028	0.500	0.69
1.219	A2910	100	0.028	0.500	0.69
1.300	A2911	60	0.028	0.500	0.69
1.380	A2912	60	0.028	0.500	0.81
1.630	A2913	60	0.028	0.500	0.81
2.130	A2917	40	0.028	0.500	0.81
2.300	A2919	40	0.028	0.500	0.81

# Hose Sleeves and Guards

## Heavy-Duty Poly Hose Guard

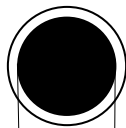

Poly Hose ID

A heavy-duty hose guard can be easily placed around a single or bundle of hydraulic and pneumatic hose. It protects against abrasion and also provides crush resistance, reducing or eliminating costly premature hose failures.

### Benefits

Resists oils, lubricants, gasoline and most solvents.

### Operating Temperature Range

-100°F to +220°F

### Color

Black

### Construction

High Density Polyethylene

Guard I.D.	Part Number	Wall Thickness	Guard O.D.	Roll Length(ft)
0.492	A9900	.069	.630	100
0.668	A9901	.086	.840	100
1.014	A9902	.118	1.250	100
1.600	A9903	.150	1.900	50
2.457	A9904	.209	2.875	50
3.065	A9905	.218	3.500	35

## Abrasion Sleeve MSHA Accepted ISO 6945



Abrasion sleeve is used to help safeguard hose covers from abrasions and cuts. The sleeve is also useful for bundling two or more hose assemblies together, adding to its protective qualities. It is available in .045" thin-wall and .090" thick-wall sleeving.

### Application

- Agriculture
- Logging
- Construction
- Mining

### Construction

Bulk continuous filament nylon

### Note:

Wall thickness is for single wall.

\* Add side sleeve onto the hose before assembling the ends. After assembly, clamp the hose onto the fittings.

Sleeve I.D.	.045" Thin Wall Part No.	.090" Thick Wall Part No.	Package Length* (ft)	Flat I.D.
0.90	A4900	A3900	100	1.32-1.51
1.06	A4901	A3901	100	1.57-1.76
1.22	A4902	A3902	100	1.82-2.01
1.35	A4903	A3903	100	2.03-2.21
1.66	A4904	A3904	100	2.63-2.87
1.81	A4905	A3905	100	2.75-2.94
2.19	A4906	A3906	100	3.43-3.53
2.62	A4907	A3907	100	4.02-4.21
2.80	A4908	A3908	100	4.43-4.62

\*Package contains two pieces that are not less than 30 feet long each.

## Locator Clamp

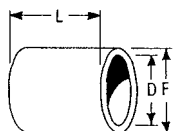

Locator clamps are designed for crimping to H14510 or H42510 hydraulic hose to provide a support for routing clamps. They are popular in Case equipment applications.

### Note:

Crimp using collet T-400-5C and spacer ring T-400-62 (yellow), flat side up.

Hose I.D.	Part Number	L	D	F
5/8	A4910	1.60	1.084	1.25

# Hose Sleeves and Guards

## Hose Bend Restrictors



For use in protecting the last section of hose at the fitting connection, bend restrictors are designed to allow for an appropriate degree of “bend” without compromising the integrity of hose assemblies. They are also recommended for hose assemblies that receive substantial handling, such as in pressure washer, air, oil, and hydraulic fluid transfer applications.

### Construction

Plastisol MR 436 gloss PVC

### Note:

Colors Red, Blue, Green and Yellow available by special order.

Restrictor I.D.	Part Number	Restrictor Length (Inch)	Hose Type Application
0.530	A5953	6	H14504, H00904
0.625	A5962	6	H10404, H20906, H24504, H34504, H42504
0.690	A5969	6	H14506, H34506
0.750	A5975	7	H10406, H20908, H24506, H30006
0.840	A5984	7	H10408, H14508, H24508
0.875	A5987	7	H34508

## Firesleeve



Firesleeve is a flame-resistant sheathing constructed of tightly woven fiberglass, which is coated with a specially compounded, highly temperature-resistant silicone rubber. Firesleeve offers protection in high temperature environments with heat extremes. It is not compatible with hydrocarbons.

### Temperature Range

- Continuous exposure up to 500°F
- Up to 2000°F for 15 to 20 minutes
- Up to 3000°F for durations of 15 to 30 seconds

### Color

Red-Orange

### Note:

Refer to application chart on pages A-33-34 for Firesleeve part numbers for specific Weatherhead hose.

Sleeve I.D.	Part Number	Roll Length (ft)
0.50	A6908	100
0.63	A6910	100
0.75	A6912	100
0.88	A6914	100
1.00	A6916	100
1.25	A6920	100
1.50	A6924	100
1.75	A6928	100
2.00	A6932	50
2.25	A6936	50
3.00	A6948	50

## Firesleeve Tape



### ⚠ CAUTION

Tests should be conducted to determine the suitability of Firesleeve for each application.

Tape Coverage	Part Number	Roll Length
All sizes	A6900W	1x432

Firesleeve tape provides protection in high temperature environments. It acts as an end sealant in preventing moisture and hydraulic oils from wicking into the inner braids of Firesleeve.

### Construction

High temperature-resistant, non-adhesive, silicone elastomer

### Operating Temperature Range

+475° continuous.

# Hose Sleeves and Guards

Hose Type	Dash Size	Hose Clamp	Round-Wire Spring Guard	Flat-Wire Spring Guard	Nylon (.45) Abrasion Sleeve	Nylon (.90) Abrasion Sleeve	Silicone Fiberglass Firesleeve	Poly Hose Guard
H009	04	HK0913	A1901	A2901	A4900	A3900	A6910	A9901
	05	HK1013	A1902	A2902	A4900	A4900	A6914	A9901
	06	HK1113	A1903	A2904	A4901	A3901	A6916	A9901
	08	HK1313	A1905	A2905	A4901	A3901	A6916	A9902
	12	HK1813	A1910	A2909	A4902	A3902	A6920	A9903
H017	04	HK1013	A1902	A2902	A4900	A3900	A6912	A9901
	06	HK1313	A1905	A2905	A4900	A3900	A6914	A9902
	08	HK1613	A1907	A2907	A4901	A3901	A6920	A9902
	12	HK2117	A1912	A2911	A4903	A3903	A6924	A9903
	16	HK2517	A1913	A2913	A4904	A3904	A6928	A9903
	20	HK2917	A1916	A2913	A4906	A3906	A6932	A9904
H039	12	HK2117	A1913	A2913	A4904	A3904	A6928	A9903
	16	HK2517	A1916	A2913	A4905	A3605	A6932	A9904
	20	HK2917	A1917	A2917	A4906	A3906	A6932	A9904
	24	HK3317	A1919	A2917	A4907	A3907	A693	6A9904
	32	HK3817	—	—	A4908	A3908	A6948	A9905
H039h	12	HK2117	A1913	A2913	A4904	A3904	A6928	A9903
	16	HK2517	A1916	A2913	A4905	A3605	A6932	A9904
	20	HK2917	A1916	A2913	A4906	A3906	A6932	A9904
	24	HK3317	A1919	A2917	A4907	A3907	A6936	A9904
	32	HK3817	—	—	A4908	A3908	A6948	A9905
H057	03	HK0709	A1900	A2900	A4900	A3900	A6910	A9900
	04	HK1013	A1901	A2901	A4900	A3900	A6912	A9901
	05	HK1013	A1902	A2902	A4900	A3900	A6914	A9901
	06	HK1113	A1903	A2904	A4900	A3900	A6914	A9901
	07	HK1213	A1904	A2904	A4901	A3901	A6916	A9902
	08	HK1313	A1905	A2905	A4901	A3901	A6916	A9902
H059	04	HK0913	A1901	A2901	A4900	A3900	A6912	A9901
	05	HK1013	A1902	A2902	A4900	A3900	A6912	A9901
	06	HK1213	A1904	A2904	A4901	A3901	A6916	A9902
	08	HK1313	A1905	A2905	A4901	A3901	A6916	A9902
	10	HK1613	A1907	A2907	A4902	A3902	A6916	A9902
	12	HK1813	A1910	A2909	A4904	A3904	A6924	A9903
	16	HK2117	A1912	A2911	A4905	A3905	A6928	A9903
H069	04	HK0913	A1902	A2901	A4900	A3900	A6912	A9901
	05	HK1013	A1903	A2902	A4900	A3900	A6912	A9901
	06	HK1213	A1904	A2904	A4901	A3901	A6912	A9902
	08	HK1413	A1905	A2905	A4901	A3901	A6916	A9902
	10	HK1613	A1907	A2907	A4902	A3902	A6916	A9902
	12	HK1913	A1910	A2909	A4903	A3903	A6920	A9903
	16	HK2117	A1912	A2910	A4904	A3904	A6924	A9903
	20	HK2517	A1913	A2913	A4906	A3906	A6928	A9903
	24	HK2117	A1916	A2917	A4907	A3907	A6932	A9904
	32	—	A1919	A2919	—	—	—	A9904
	40	—	—	—	—	—	—	A9905
48	—	—	—	—	—	—	—	
H077	04	HK0913	A1901	A2901	A4900	A3900	A6912	A9901
	05	HK1013	A1902	A2902	A4900	A3900	A6914	A9901
	06	HK1113	—	A2904	A4901	A3901	A6914	A9901
H100	04	HK0913	A1900	A2900	A4900	A3900	A6912	A9901
	05	HK1013	A1902	A2902	A4900	A3900	A6912	A9901
	06	HK1113	A1903	A2904	A4900	A3900	A6912	A9902
	08	HK1313	A1905	A2905	A4901	A3901	A6916	A9902
	10	HK1613	A1907	A2907	A4902	A3902	A6920	A9902
	12	HK1813	A1908	A2909	A4903	A3903	A6924	A9903

# Hose Sleeves and Guards

Hose Type	Dash Size	Hose Clamp	Round-Wire Spring Guard	Flat-Wire Spring Guard	Nylon (.45) Abrasion Sleeve	Nylon (.90) Abrasion Sleeve	Silicone Fiberglass Firesleeve	Poly Hose Guard
H101	04	HK0913	A1902	A2902	A4900	A3900	A6910	A9901
	05	HK1013	A1903	A2902	A4900	A3900	A6912	A9901
	06	HK1113	A1904	A2904	A4900	A3900	A6912	A9901
	08	HK1413	A1905	A2905	A4902	A3902	A6916	A9902
	10	HK1613	A1907	A2907	A4903	A3903	A6920	A9902
	12	HK1813	A1908	A2909	A4903	A3903	A6924	A9903
	16	HK2317	A1913	A2913	A4904	A3904	A6928	A9903
H104	04	HK1903	A1902	A2902	A4900	A3900	A6912	A9901
	06	HK1213	A1904	A2904	A4900	A3900	A6914	A9902
	08	HK1413	A1907	A2907	A4902	A3902	A6920	A9902
	10	HK1613	A1907	A2907	A4903	A3903	A6924	A9902
	12	HK1913	A1910	A2910	A4903	A3903	A6924	A9903
	16	HK2317	A1913	A2913	A4904	A3904	A6928	A9903
	20	HK2117	A1916	A2917	A4906	A3906	A6936	A9904
H0105	04	HK1113	A1903	A2904	A4900	A3900	A6914	A9901
	06	HK1313	A1905	A2905	A4903	A3903	A6914	A9902
	08	HK1513	A1907	A2907	A4904	A3904	A6924	A9902
	12	HK2017	A1910	A2909	A4904	A3904	A6924	A9903
	16	HK2517	A1913	A2913	A4906	A3906	A6932	A9903
H114	04	HK0913	A1902	A2902	A4900	A3900	A6912	A9901
	06	HK1113	A1904	A2904	A4900	A3900	A6914	A9901
	08	HK1413	A1906	A2906	A4902	A3902	A6920	A9902
H115	04	HK1113	A1902	A2902	A4900	A3900	A6912	A9901
	05	HK1113	A1904	A2904	A4900	A3900	A6912	A9901
	06	HK1213	A1905	A2905	A4900	A3900	A6914	A9902
	08	HK1513	A1907	A2907	A4901	A3901	A6920	A9902
	12	HK2017	A1910	A2910	A4903	A3903	A6924	A9903
	16	HK2317	A1913	A2913	A4904	A3904	A6928	A9903
	20	HK2117	A1916	A2917	A4906	A3906	A6936	A9904
H145	04	HK0913	A1902	A2902	A4900	A3900	A6912	A9900
	06	HK1113	A1904	A2904	A4901	A3901	A6916	A9901
	08	HK1413	A1906	A2906	A4901	A3901	A6916	A9902
	10	HK1613	A1908	A2908	A4903	A4903	A6924	A9902
	12	HK1813	A1910	A2910	A4903	A3903	A6924	A9902
	16	HK2317	A1913	A2913	A4904	A3904	A6928	A9903
	20	HK2117	A1916	A2917	A4906	A3906	A6936	A9904
H145R	04	HK0913	A1900	A2901	A4900	A3900	A6912	A9900
	06	HK1113	A1904	A2904	A4901	A3901	A6916	A9901
	08	HK1413	A1906	A2906	A4901	A3901	A6916	A9902
	10	HK1613	A1908	A2908	A4903	A4903	A6924	A9902
	12	HK1813	A1910	A2910	A4903	A3903	A6924	A9902
	16	HK2317	A1913	A2913	A4904	A3904	A6928	A9903
	20	HK2117	A1916	A2917	A4906	A3906	A6936	A9904
H146	04	HK0913	A1902	A2902	A4900	A3900	A6912	A9901
	06	HK1213	A1905	A2905	A4901	A3901	A6914	A9902
	08	HK1413	A1906	A2906	A4901	A3901	A6920	A9903
H166	04	HK0913	A1902	A2901	A4900	A3900	A6912	A9901
	05	HK1013	A1902	A2902	A4900	A3900	A6912	A9901
	06	HK1013	A1904	A2904	A4901	A3901	A6916	A9902
	08	HK1413	A1905	A2905	A4901	A3901	A6916	A9902
	10	HK1613	A1907	A2907	A4901	A3901	A6920	A9902
	12	HK1913	A1910	A2910	A4903	A3903	A6924	A9903
	16	HK2117	A1912	A2911	A4905	A3905	A6932	A9903
20	HK2517	A1913	A2913	A4905	A3905	—	A9903	

# Hose Sleeves and Guards

Hose Type	Dash Size	Hose Clamp	Round-Wire Spring Guard	Flat-Wire Spring Guard	Nylon (.45) Abrasion Sleeve	Nylon (.90) Abrasion Sleeve	Silicone Fiberglass Firesleeve	Poly Hose Guard
H169	04	HK1013	A1902	A2901	A4900	A3900	A6914	A9901
	05	HK1113	A1902	A2902	A4900	A3900	A6914	A9901
	06	HK1213	A1904	A2904	A4901	A3901	A6916	A9902
	08	HK1413	A1905	A2905	A4901	A3901	A6916	A9902
	10	HK1613	A1907	A2907	A4901	A3901	A6920	A9902
	12	HK1913	A1910	A2910	A4903	A3903	A6924	A9903
	16	HK2117	A1912	A2912	A4905	A3905	A6932	A9903
	20	HK2517	A1913	A2913	A4904	A3904	—	A9903
	24	HK2917	A1916	A2917	A4907	A3907	A6948	A9904
	32	HK3417	A1919	A2919	—	—	—	A9904
H190	04	HK1013	A1902	A2902	A4900	A3900	A6914	A9901
	06	HK1213	A1904	A2904	A4901	A3901	A6916	A9902
	08	HK1413	A1906	A2906	A4901	A3901	A6916	A9902
	10	HK1613	A1908	A2908	A4901	A3901	A6920	A9902
	12	HK1913	A1910	A2910	A4903	A3903	A6924	A9903
	16	HK2517	A1913	A2913	A4905	A3905	A6932	A9903
H190H	04	HK1013	A1902	A2902	A4900	A3900	A6914	A9901
	06	HK1213	A1904	A2904	A4901	A3901	A6916	A9902
	08	HK1413	A1906	A2906	A4901	A3901	A6916	A9902
	10	HK1613	A1908	A2908	A4901	A3901	A6920	A9902
	12	HK1913	A1910	A2910	A4903	A3903	A6924	A9903
	16	HK2517	A1913	A2913	A4905	A3905	A6932	A9903
H201	04	HK0913	A1902	A2902	A4900	A3900	A3612	A9901
	06	HK1113	A1904	A2904	A4901	A3901	A6914	A9901
	08	HK1313	A1905	A2905	A4901	A3901	A6916	A9902
	10	HK1613	A1907	A2907	A4902	A3902	A6920	A9902
	12	HK1813	A1908	A2909	A4903	A3903	A6924	A9903
H209	04	HK0809	A1900	A2900	A4900	A3900	A6910	A9900
	05	HK0913	A1902	A2902	A4900	A3900	A6914	A9900
	06	HK1013	A1903	A2902	A4901	A3901	A6914	A9900
	08	HK1213	A1905	A2905	A4901	A3901	A6920	A9902
H213	04	HK0913	A1901	A2901	A4900	A3900	A6910	A9900
	05	HK1013	A1902	A2902	A4900	A3900	A6914	A9900
	06	HK1113	A1903	A2904	A4900	A3900	A6914	A9901
	08	HK1313	A1905	A2905	A4901	A3901	A6920	A9902
	10	HK1413	A1907	A2907	A4902	A3902	A6920	A9902
	12	HK1713	A1908	A2908	A4903	A3903	A6924	A9902
	16	HK2017	A1912	A2911	A4904	A3904	A6928	A9903
H229	04	HK0913	A1902	A2901	A4900	A3900	A6910	A9901
	06	HK1213	A1904	A2904	A4901	A3901	A6914	A9902
	08	HK1413	A1905	A2905	A4902	A3902	A6924	A9902
	10	HK1613	A1907	A2907	A4902	A3902	A6924	A9902
H229	12	HK2617	A1912	A2912	A4905	A3905	A6928	A9903
	16	HK2117	A1912	A2912	A4906	A3906	A6932	A9906
H239	04	HK0913	A1902	A2901	A4900	A3900	A6912	A9901
	06	HK1213	A1904	A2904	A4900	A3900	A6914	A9902
	08	HK1313	A1905	A2905	A4901	A3901	A6920	A9902
	10	HK1613	A1907	A2907	A4902	A3902	A6920	A9902
	12	HK1813	A1910	A2910	A4905	A3905	A6928	A9903
	16	HK2117	A1912	A2912	A4906	A3906	A6932	A9903
	20	HK2517	A1913	A2913	A4904	A3904	—	A9903

# Hose Sleeves and Guards

Hose Type	Dash Size	Hose Clamp	Round-Wire Spring Guard	Flat-Wire Spring Guard	Nylon (.45) Abrasion Sleeve	Nylon (.90) Abrasion Sleeve	Silicone Fiberglass Firesleeve	Poly Hose Guard
H243	03	HK0709	A1900	A2900	A4900	A3900	A6910	A9900
	04	HK0709	A1900	A2900	A4900	A3900	A6914	A9900
	05	HK0809	A1902	A2902	A4900	A3900	A6914	A9901
	06	HK0913	A1904	A2904	A4901	A3901	A6920	A9901
	08	HK1113	A1905	A2905	A4902	A3902	A6920	A9902
	12	HK1513	A1910	A2910	A4904	A3904	A6924	A9903
	16	HK1913	A1912	A2912	A4905	A3905	A6928	A9904
H245	04	HK1013	A1902	A2902	A4900	A3900	A6914	A9901
	06	HK1013	A1904	A2904	A4903	A3903	A6920	A9902
	08	HK1213	A1906	A2906	A4904	A3904	A6924	A9902
	10	HK1413	A1908	A2908	A4904	A3904	A6924	A9902
	12	HK1613	A1910	A2910	A4905	A3905	A6928	A9903
	16	HK2317	A1913	A2913	A4906	A3906	A6932	A9903
	20	HK2917	A1916	A2917	A4907	A3907	—	A9904
H265	04	HK0913	A1902	A2902	A4900	A3900	A6914	A9901
	06	HK1213	A1904	A2904	A4901	A3901	A6916	A9901
	08	HK1413	A1905	A2905	A4902	A3902	A6920	A9902
	12	HK1813	A1910	A2910	A4904	A3904	A6928	A9903
	16	HK2217	A1913	A2913	A4905	A3905	A6932	A9903
H275	03	HK0809	A1900	A2900	A4900	A3900	A6912	A9900
	04	HK0913	A1902	A2902	A4900	A3900	A6914	A9901
	06	HK1113	A1903	A2904	A4901	A3901	A6916	A9901
	08	HK1413	A1905	A2905	A4902	A3902	A6920	A9902
	12	HK1813	A1910	A2909	A4904	A3904	A6924	A9902
	16	HK2217	A1913	A2913	A4905	A3905	A6928	A9903
	20	HK2917	A1916	A2916	A4907	A3907	A6936	A9904
	24	HK3217	A1917	A2917	A4908	A3908	A6940	A9904
	32	HK3817	—	—	—	—	A6948	A9904
H277	03	HK0709	A1900	A2900	A4900	A3900	A6910	A9900
	04	HK0709	A1900	A2900	A4900	A3900	A6914	A9900
	05	HK0809	A1900	A2900	A4901	A3901	A6920	A9902
	06	HK0913	A1903	A2902	A4902	A3902	A6920	A9902
	08	HK1113	A1904	A2904	A4901	A3901	A6920	A9902
	12	HK1513	A1907	A2907	A4904	A3904	A6928	A9903
	16	HK1913	A1912	A2912	A4905	A3905	A6932	A9903
H280	04	HK1013	A1902	A2902	A4900	A3900	A6914	A9901
	06	HK1213	A1904	A2904	A4901	A3901	A6920	A9902
	08	HK1413	A1906	A2906	A4901	A3901	A6920	A9902
	10	HK1613	A1908	A2908	A4904	A3904	A6928	A9903
	12	HK1913	A1910	A2910	A4904	A3904	A6928	A9903
	16	HK2517	A1913	A2913	A4905	A3905	A6932	A9903
H285	04	HK0913	A1900	A2900	A4900	A3900	A6914	A9900
	06	HK1213	A1903	A2902	A4901	A3901	A6916	A9901
	08	HK1413	A1905	A2905	A4901	A3901	A6920	A9902
	12	HK1813	A1910	A2909	A4904	A3904	A6924	A9903
	16	HK2217	A1912	A2912	A4905	A3905	A6928	A9903
H290	04	HK1113	A1903	A2904	A4900	A3900	A6914	A9901
	06	HK1313	A1905	A2905	A4901	A3901	A6916	A9902
	08	HK1513	A1907	A2907	A4902	A3902	A6920	A9902
	10	HK1713	A1910	A2910	A4904	A3904	A6924	A9903
	12	HK2017	A1912	A2912	A4904	A3904	A6928	A9903
	16	HK2517	A1913	A2913	A4904	A3904	A6932	A9903



# Hose Sleeves and Guards

Hose Type	Dash Size	Hose Clamp	Round-Wire Spring Guard	Flat-Wire Spring Guard	Nylon (.45) Abrasion Sleeve	Nylon (.90) Abrasion Sleeve	Silicone Fiberglass Firesleeve	Poly Hose Guard
H290H	04	HK1113	A1903	A2904	A4900	A3900	A6914	A9901
	06	HK1313	A1905	A2905	A4901	A3901	A6916	A9902
	08	HK1513	A1907	A2907	A4902	A3902	A6920	A9902
	10	HK1713	A1910	A2910	A4904	A3904	A6924	A9903
	12	HK2017	A1912	A2912	A4904	A3904	A6928	A9903
	16	HK2517	A1913	A2913	A4904	A3904	A6932	A9903
H324	06	HK1313	A1905	A2905	A4900	A3900	A6924	A9902
H325	04	HK1013	A1902	A2902	A4900	A3900	A6914	A9901
	06	HK1313	A1905	A2905	A4900	A3900	A3616	A9902
	08	HK1513	A1907	A2907	A4901	A3901	A6920	A9902
	12	HK2017	A1912	A2912	A4904	A3904	A6928	A9903
	16	HK2517	A1913	A2913	A4904	A3904	A3932	A9903
H332	04	HK1013	A1903	A2902	A4900	A3900	A6914	A9901
	06	HK1313	A1905	A2905	A4900	A3900	A3616	A9902
	08	HK1513	A1907	A2907	A4901	A3901	A6920	A9902
	12	HK2017	A1910	A2910	A4904	A3904	A6928	A9903
H335	03	HK0913	A1901	A2901	A4900	A3900	A6916	A9901
	04	HK1113	A1903	A2904	A4901	A3901	A6916	A9902
	06	HK1313	A1905	A2905	A4902	A3902	A6920	A9902
	08	HK1513	A1907	A2907	A4902	A3902	A6924	A9902
	12	HK1913	A1910	A2910	A4903	A3903	A6924	A9903
	16	HK2517	A1913	A2913	A4905	A3905	A6928	A6603
H336	03	HK0913	A1901	A2901	A4900	A3900	A6916	A9901
	04	HK1113	A1903	A2904	A4901	A3901	A6916	A9902
	06	HK1313	A1905	A2905	A4902	A3902	A6920	A9902
	08	HK1513	A1907	A2907	A4902	A3902	A6924	A9903
	12	HK1913	A1910	A2910	A4903	A3903	A6924	A9903
	16	HK2517	A1913	A2913	A4905	A3905	A6928	A9902
H338	06	HK1313	A1905	A2905	A4900	A3900	A6920	A9902
	08	HK1513	A1907	A2907	A4901	A3901	A6920	A9902
H345	04	HK0913	A1900	A2900	A4900	A3900	A6916	A9901
	06	HK1113	A1904	A2904	A4900	A3900	A6920	A9902
	08	HK1313	A1906	A2906	A4901	A3901	A6924	A9902
H350	06	HK1313	A1904	A2904	A4901	A3901	A6916	A9902
	08	HK1513	A1906	A2906	A4901	A3901	A6916	A9902
	10	HK1813	A1908	A2908	A4904	A3904	A6924	A9903
	12	HK2017	A1910	A2910	A4905	A3905	A6928	A9903
	16	HK2517	A1913	A2913	A4906	A3906	A6936	A9903
H366	06	HK1213	A1904	A2904	A4901	A3901	A6916	A9902
	08	HK1413	A1905	A2905	A4901	A3901	A6916	A9902
H400	04	HK1013	A1903	A2904	A4901	A3901	A6916	A9902
	06	HK1313	A1905	A2905	A4901	A3901	A6920	A9903
	08	HK1413	A1907	A2907	A4901	A3901	A6920	A9903
	10	HK1713	A1909	A2909	A4903	A3903	A6920	A9903

# Hose Sleeves and Guards

Hose Type	Dash Size	Hose Clamp	Round-Wire Spring Guard	Flat-Wire Spring Guard	Nylon (.45) Abrasion Sleeve	Nylon (.90) Abrasion Sleeve	Silicone Fiberglass Firesleeve	Poly Hose Guard
H425	04	HK1113	A1903	A2904	A4900	A3900	A6916	A9902
	06	HK1313	A1905	A2905	A4900	A3900	A6916	A9902
	08	HK1513	A1907	A2907	A4902	A3902	A6920	A9902
	10	HK1713	A1910	A2909	A4903	A3903	A6920	A9903
	12	HK2017	A1912	A2911	A4903	A3903	A6924	A9903
	16	HK2517	A1913	A2913	A4905	A3905	A6928	A9903
	20	HK3117	A1917	A2917	A4906	A3906	A6936	A9904
	24	HK3417	A1919	A2919	A4907	A3907	—	A9904
	32	HK3817	—	—	—	—	—	A9905
H430	06	HK1413	A1906	A2906	A4901	A3901	A6916	A9902
	08	HK1613	A1908	A2908	A4904	A3904	A6924	A9903
	10	HK1913	A1909	A2909	A4904	A3904	A6924	A9903
	12	HK2117	A1912	A2912	A4905	A3905	A6928	A9903
	16	HK2517	A1913	A2913	A4906	A3906	A6936	A9903
	20	HK3117	A1917	A2917	A4907	A3907	—	A9904
	24	—	A1919	A2919	A4907	A3907	—	A9904
	32	HK3817	—	—	—	—	—	A9905
	H430R	06	HK1413	A1906	A2907	A4901	A3901	A6916
08		HK1613	A1908	A2908	A4904	A3904	A6924	A9903
12		HK2117	A1912	A2912	A4905	A3905	A6928	A9903
16		HK2517	A1913	A2913	A4906	A3906	A6936	A9903
20		HK3117	A1917	A2917	A4907	A3907	—	A9904
24		—	A1919	A2919	A4907	A3907	—	A9904
32		HK3817	—	—	—	—	—	A9905
H435	04	HK0809	A1900	A2900	A4900	A3900	A6912	A9901
	05	HK1013	A1902	A2902	A4900	A3900	A6912	A9901
	06	HK1113	A1904	A2904	A4900	A3900	A6916	A9901
	08	HK1413	A1906	A2906	A4902	A3902	A6920	A9902
	12	HK1813	A1910	A2910	A4903	A3903	A6924	A9903
	16	HK2317	A1913	A2913	A4904	A3904	A6928	A9903
	H436	04	HK0809	A1900	A2900	A4900	A3900	A6912
05		HK1013	A1902	A2902	A4900	A3900	A6912	A9901
06		HK1113	A1904	A2904	A4901	A3901	A6916	A9901
08		HK1413	A1906	A2906	A4902	A3902	A6920	A9902
12		HK1813	A1910	A2910	A4903	A3903	A6924	A9903
16		HK2317	A1913	A2913	A4904	A3904	A6928	A9903
H464		12	HK2317	A1912	A2912	A4903	A3903	A6920
	16	HK2517	A1913	A2913	A4904	A3904	A6924	A9902
	20	HK3117	A1916	—	A4905	A3905	A6928	A9903
	24	HK3417	A1919	A2919	A4906	A3906	A6936	A9903
	32	HK3817	—	—	A4908	A3908	A6948	A9904
H470	08	HK1713	A1908	A2908	A4901	A3901	A6916	A9902
	12	HK2117	A1912	A2912	A4904	A3904	A6928	A9903
	16	HK2517	A1913	A2913	A4904	A3904	A6928	A9903
	20	HK3217	A1917	A2917	A4906	A3906	A6936	A9904
	24	HK3417	A1919	A2919	A4907	A3907	—	A9904
	32	HK3817	—	—	—	—	—	A9905

# Hose Sleeves and Guards

Hose Type	Dash Size	Hose Clamp	Round-Wire Spring Guard	Flat-Wire Spring Guard	Nylon (.45) Abrasion Sleeve	Nylon (.90) Abrasion Sleeve	Silicone Fiberglass Firesleeve	Poly Hose Guard
H545	04	HK1013	A1902	A2902	A4900	A3900	A6912	A9901
	06	HK1113	A1904	A2904	A4901	A3901	A6916	A9901
	08	HK1513	A1906	A2906	A4901	A3901	A6916	A9902
	10	HK1713	A1907	A2907	A4903	A3903	A6924	A9902
	12	HK2017	A1910	A2910	A4904	A3904	A6928	A9903
	16	HK2517	A1913	A2913	A4906	A3906	A6936	A9903
	H569	04	HK0913	A1901	A2901	A4900	A3900	A6912
05		HK1113	A1902	A2902	A4900	A3900	A6912	A9901
06		HK1213	A1904	A2904	A4901	A3901	A6916	A9902
08		HK1413	A1905	A2905	A4901	A3901	A6916	A9902
10		HK1613	A1907	A2907	A4901	A3901	A6916	A9902
12		HK1913	A1910	A2910	A4903	A3903	A6924	A9903
16		HK2117	A1912	A2912	A4904	A3904	A6928	A9903
20		HK2517	A1913	A2913	A4906	A3906	A6936	A9903
H757	06	HK1013	A1902	A2902	A4900	A3900	A6916	A9901
	08	HK1213	A1904	A2904	A4900	A3900	A6920	A9902
	10	HK1313	A1905	A2905	A4901	A3901	A6920	A9902
	12	HK1613	A1907	A2907	A4902	A3902	A6924	A9902

# Ready-Made Hose Assemblies

## Coiled Air Brake Tube Assemblies

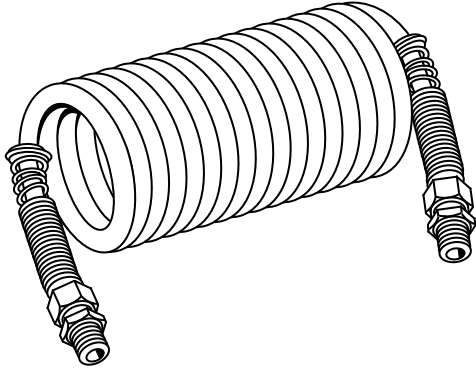

Part Number	Tube O.D.	Male Pipe	Working Length(ft)	Pigtail Length
12CA12-12*	1/2	1/2	12	12
12CAR12-12	1/2	1/2	12	12
12CAB12-12	1/2	1/2	12	12
15CA12-12*	1/2	1/2	12	12
15CA48-12*	1/2	1/2	15	48/12
15CAR48-12	1/2	1/2	15	48/12
15CAB48-12	1/2	1/2	15	48/12

\* Each catalog number contains a coiled red assembly and a coiled blue assembly.

### Features / Benefits

- Conform to SAE J844 Type B and SAE J1131
- Conform to DOT FMVSS 571.106

### Construction

- Brass end fittings with spring guards and 1/2" male pipe connections
- Zinc plated spring guards for maximum corrosion resistance
- Preassembled for immediate installation

### Maximum Operating pressure

150 psi

### Minimum Burst Pressure

950 psi.

### Operating Temperature Range

-54°C to +93°C  
(-65°F to +200°F).

### Color Coding

Red for emergency–blue for service.

## Gladhand Couplings

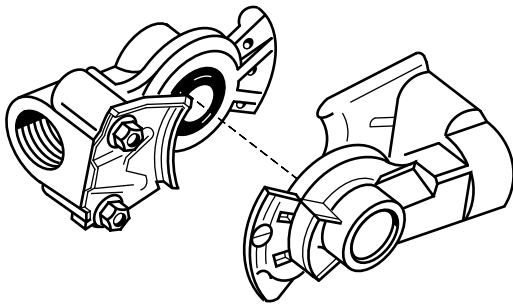

Description	Part Number
Service – Signal (Connects only to service)	W79850
Emergency – Supply line (Connects only to emergency)	W79851
Universal (Connects to all three styles)	W76150
Gladhand Seal	W14630**

\*\* For use with W79850, W79851, and W76150 gladhands

### Features / Benefits

- Conform to SAE J318
- Connect to 1/2" pipe

### Construction

- Die cast aluminum body

# Ready-Made Hose Assemblies

## Air Compressor Discharge Teflon® Hose Assembly

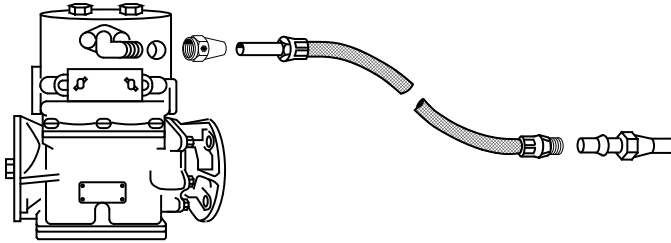

Ready-made hose Teflon® assemblies eliminate tubing failures caused by vibration and heat. They make excellent replacements for troublesome copper tubing running from the air compressor discharge to the reservoir. The assemblies are easy to install with standard air brake nuts and sleeves. No special fittings or adapters are needed.

**Max. Working Pressure**  
1000 psi

**Operating Temperature Range**

-65°F to +450°F  
(-18°C to +232°C)

## Standpipe to Standpipe



Description	Length	Part Number
5/8" hose I.D. – 5/8" tube	24"	WTT024
	36"	WTT036
5/8" hose I.D. – 3/4" tube	36"	WTT236

## SAE 45° Flare to SAE 45° Flare



Description	Length	Part Number
1/2" hose I.D. – 5/8" tube	34"	W44034
	38"	W44038
	40"	W44040
	42"	W44042
	48"	W44048
	50"	W44050
	52"	W44052
	54"	W44054
67"	W44067	

Teflon® is a registered trademark of DuPont used under license by Eaton.

# Ready-Made Hose Assemblies

## Grease Hose Whip Ends for High-Pressure Grease Applications

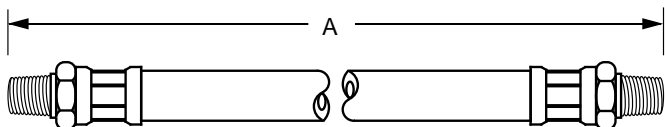

Part Number	Tube O.D.	Male Pipe	Working Length	Pigtail Length
11312	1/8-27	3/16"	12"	Rubber
11318	1/8-27	3/16"	18"	Rubber
11352	1/8-27	3/16"	12"	Nylon
11358	1/8-27	3/16"	18"	Nylon

**Maximum Operating Pressure**  
3000 psi

**Operating Temperature Range**  
-40°F to +200°F (-40°C to +93°C)

**Note:**  
Use with hand-operated grease gun only!

**Hose Part No. H993903**

## Power Trim Teflon® Hose Assembly

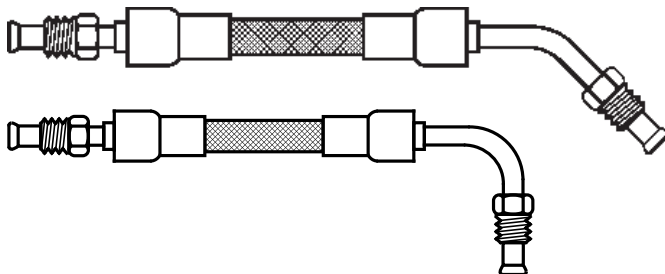

Part Number	Overall Length	Fiting Description
1909	14-1/2"	3/16" Inv. Nut Straight x 3/16" Inv. Nut 90° Elbow
1910	14-1/2"	3/16" Inv. Nut Straight x 3/16" Inv. Nut 45° Elbow

Expand service to marinas with the inboard/outboard power trim teflon hose assemblies, available in the most popular size, 3/16" I.D., 14-1/2" long, with inverted nut end styles. Marine applications will benefit from the non-aging and temperature resistant qualities of Teflon®, plus the

corrosion resistance of 300 Series stainless steel fittings and braid.

**Maximum Operating Pressure**  
3000 psi

**Operating Temperature Range**  
-65°F to +450°F

Teflon® is a registered trademark of DuPont used under license by Eaton.

# Ready-Made Hose Assemblies

## Air Brake Air Chamber Hose Lines

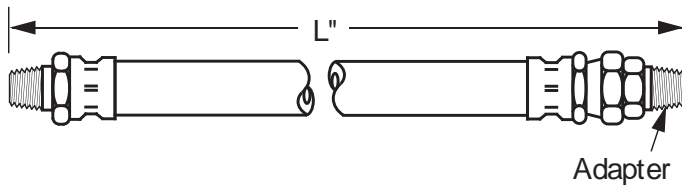

### Features / Benefits

- Low cost
- Ready to install
- Available in both 3/8" and 1/2" I.D.
- H338 Weatherhead Air Brake Hose

Hose Assembly I.D.	Male Pipe	Air Brake Swivel*	Length L	Factory Made Assembly Part Number**
1/2"	3/8"	3/8"	15"	38353-01500
1/2"	3/8"	3/8"	16"	38353-01600
1/2"	3/8"	3/8"	18"	38353-01800
1/2"	3/8"	3/8"	19"	38353-01900
1/2"	3/8"	3/8"	20-3/8"	38353-02037
1/2"	3/8"	3/8"	22"	38353-02200
1/2"	3/8"	3/8"	23"	38353-02300
1/2"	3/8"	3/8"	24"	38353-02400
1/2"	3/8"	3/8"	26"	38353-02600
1/2"	3/8"	3/8"	28-3/8"	38353-02837
1/2"	3/8"	3/8"	30"	38353-03000
1/2"	3/8"	3/8"	32"	38353-03200
1/2"	3/8"	3/8"	34-3/8"	38353-03437
1/2"	3/8"	3/8"	36"	38353-03600
1/2"	3/8"	3/8"	41-1/8"	38353-04112
1/2"	3/8"	3/8"	44"	38353-04400
1/2"	3/8"	3/8"	46"	38353-04600
1/2"	3/8"	3/8"	48"	38353-04800
1/2"	3/8"	3/8"	60"	38353-06000
1/2"	3/8"	3/8"	72"	38353-07200

\*Includes 3/8" A.B.S. to 3/8" male pipe adapter.

\*\*Air chamber hose assemblies can also be made using Weatherhead H338 hose, 33808P-106 and 33808P-Y76 hose ends, and 1390x6x6 adapter with the Coll-O-Crimp field crimping system.

# Ready-Made Hose Assemblies

## Air Brake Air Chamber Hose Lines

Hose Assembly I.D.	Male Pipe	Air Brake Swivel*	Length L	Factory Made Assembly Part Number**
3/8"	1/4"	3/8"	18-1/8"	38166-01812
3/8"	1/4"	3/8"	20-3/8"	38166-02137
3/8"	1/4"	3/8"	22"	38166-02200
3/8"	1/4"	3/8"	24-1/8"	38166-02412
3/8"	1/4"	3/8"	24-7/8"	38166-02487
3/8"	1/4"	3/8"	26"	38166-02600
3/8"	1/4"	3/8"	27-5/8"	38166-02762
3/8"	1/4"	3/8"	28-3/8"	38166-02837
3/8"	1/4"	3/8"	29-1/8"	38166-02912
3/8"	1/4"	3/8"	30-1/8"	38166-03012
3/8"	1/4"	3/8"	32"	38166-03200
3/8"	1/4"	3/8"	34"	38166-03400
3/8"	1/4"	3/8"	34-3/8"	38166-03437
3/8"	1/4"	3/8"	36-1/8"	38166-03612
3/8"	1/4"	3/8"	38-1/8"	38166-03812
3/8"	1/4"	3/8"	40"	38166-04000
3/8"	1/4"	3/8"	41-1/8"	38166-04112
3/8"	1/4"	3/8"	42"	38166-04200
3/8"	1/4"	3/8"	48"	38166-04800
3/8"	1/4"	3/8"	60"	38166-06000
3/8"	1/4"	3/8"	72"	38166-07200

\*Includes 3/8" A.B.S. to 3/8" male pipe adapter.

\*\*Air chamber hose assemblies can also be made using Weatherhead H338 hose, 33808P-106 and 33808P-Y76 hose ends, and 1390x6x6 adapter with the Coll-O-Crimp field crimping system.

Hose Assembly I.D.	Male Pipe	Air Brake Swivel*	Length L	Factory Made Assembly Part Number**
3/8"	3/8"	3/8"	18"	38097-01800
3/8"	3/8"	3/8"	20"	38097-02000
3/8"	3/8"	3/8"	24"	38097-02400
3/8"	3/8"	3/8"	26"	38097-02600
3/8"	3/8"	3/8"	28"	38097-02800
3/8"	3/8"	3/8"	30"	38097-03000
3/8"	3/8"	3/8"	32"	38097-03200
3/8"	3/8"	3/8"	34"	38097-03400
3/8"	3/8"	3/8"	40"	38097-04000
3/8"	3/8"	3/8"	42"	38097-04200
3/8"	3/8"	3/8"	60"	38097-06000
3/8"	3/8"	3/8"	72"	38097-07200

\*Includes 3/8" A.B.S. to 3/8" male pipe adapter.

\*\*Air chamber hose assemblies can also be made using Weatherhead H338 hose, 33808P-106 and 33808P-Y76 hose ends, and 1390x6x6 adapter with the Coll-O-Crimp field crimping system.



# Ready-Made Hose Assemblies

## Automobile, Light Truck Gas/Oil Lines

**Maximum Working Pressure:**  
50 PSI

**Temperature Range**  
-40°F to +257°F

**Weatherhead H057 Hose**

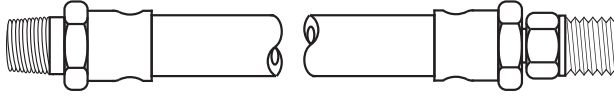

Male Pipe

Inverted Male

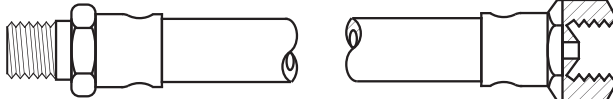

Male Pipe

Inverted Female

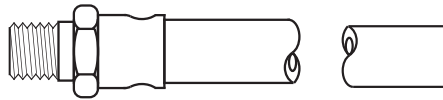

Male Pipe

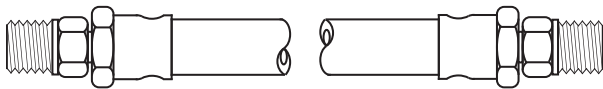

Inverted Male

Inverted Male

Part Number	Overall Length	Fitting Description
11461	10"	1/8" Male Pipe x 1/4" Inv. Male
11462	12"	1/8" Male Pipe x 1/4" Inv. Male
11463	13"	1/8" Male Pipe x 1/4" Inv. Male
11464	15"	1/8" Male Pipe x 1/4" Inv. Male
11465	21"	1/8" Male Pipe x 1/4" Inv. Male
11466	28"	1/8" Male Pipe x 1/4" Inv. Male
11474	19"	1/8" Male Pipe x 1/4" Inv. Male
11477	17"	1/8" Male Pipe x 1/4" Inv. Male
11478	24"	1/8" Male Pipe x 1/4" Inv. Male

Part Number	Overall Length	Fitting Description
11079	6-5/8"	1/8" Male Pipe x 5/16" Inv. Female
11076	8-1/4"	1/8" Male Pipe x 5/16" Inv. Female
11205	8-7/8"	1/8" Male Pipe x 5/16" Inv. Female
11215	9-3/8"	1/8" Male Pipe x 5/16" Inv. Female
11093	18"	1/8" Male Pipe x 5/16" Inv. Female
11217	7-1/2"	1/4" Male Pipe x 3/8" Inv. Female
11216	9"	1/4" Male Pipe x 3/8" Inv. Female

Part Number	Overall Length	Fitting Description
11223	15-1/4"	1/4" Male Pipe (one end only, other end blank)

Part Number	Overall Length	Fitting Description
11486	10"	1/4" Inv. Male x 1/4" Inv. Male

# Ready-Made Hose Assemblies

## Automobile, Light Truck Gas/Oil Lines\*

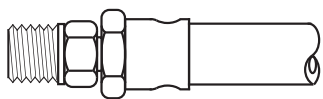

Inverted Male

## Weatherhead H057 Hose

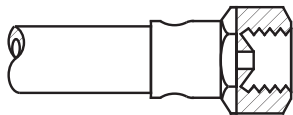

Inverted Female

Part Number	Overall Length	Fitting Inverted Description
11080	5"	1/4" Male x 1/4" Female
11224	7"	1/4" Male x 1/4" Female
11089	10-5/8"	1/4" Male x 1/4" Female
11078	7"	5/16" Male x 5/16" Female
11212	7-7/8"	5/16" Male x 5/16" Female
11041	9"	5/16" Male x 5/16" Female
11208	10-3/4"	5/16" Male x 5/16" Female

**Maximum Operating Pressure**  
50 psi

**Operating Temperature Range**  
-40°F to +257°F

Part Number	Overall Length	Fitting Inverted Description
11219	6-1/4"	5/16" Male x 5/16" Female

## Automobile, Light Truck Universal-Type Filter Lines\*

(1/4" SAE Swivel Nut to 1/8" Male Pipe)



## Weatherhead H05804 Hose

Part Number	Overall Length	Part Number	Overall Length
81430-08	8"	81430-20	20"
81430-10	10"	81430-22	22"
81430-12	12"	81430-24	24"
81430-14	14"	81430-28	28"
81430-16	16"	81430-30	30"
81430-18	18"	81430-36	36"

**Maximum Operating Pressure**  
400 psi

**Operating Temperature Range**  
-40°F to +250°F

**Note:** Hose end material is brass.

\*Hose assemblies listed are for automobile or light truck (up to 3/4-ton pickup truck) application only. Consult Eaton prior to any other use.

# Accessories

## Jetcleaner™



The Jetcleaner™ hose cleaning system offers a revolutionary solution for internal cleaning of bulk hose and finished hose assemblies. Using a low-pressure air gun, the Jetcleaner system routes a foam projectile through the hose to thoroughly remove debris remaining from cutting, skiving, and assembly operations. Available in kit form or as individual components, it is the system of choice for hose assembly professionals.

### Hose Kit (Part Number FT1355-01)

Includes:

- Jetcleaner pistol
- Hose nozzles, 1/4" through 2" ID
- Adapter ring
- Aluminum case
- Bench stand

#### Note

Hose projectiles (Part number FT1355-3-size) not included in kit.

### Small Jet Cleaner Kit (Part Number FT1355-02)

Includes:

- Jetcleaner pistol
- Hose nozzles 1/4" thru 1-1/4"
- Hose projectiles 1/4" thru 1-1/4"
- Adapter ring
- Aluminum case
- Bench stand

## Hose Insertion Gauges



### Part Number FF90308

For use with all hose with WeatherGRIP™ hose ends.

Improve hose assembly reliability with these easy-to-use aluminum gages that are designed to ensure proper hose end depth during pre-assembly.

Simply bottom the hose in the appropriately marked cavity and scribe a mark on the hose flush with the top surface of the gauge. Insert the hose end until the back of the socket is aligned with scribe line.

Part Number	Usage
FF90308-01	All hose styles that mate with -4 through -16 WeatherGRIP hose ends
FF90308-02	All hose styles that mate with -20 WeatherGRIP hose ends
FF90308-03	All hose styles that mate with -12, -16, -20 4SP/6SP hose ends

## Pressure Gauge Kit



Complete Kit Number	Component Part Number	Description	Quantity Per Kit
FF14802	FF14783	1/8" NPT Test Coupling	2
	FF14784	1/4" NPT Test Coupling	2
	FF14787	7/16-20 UNF Test Coupling	1
	FF14788	9/16-20 UNF Test Coupling	1
	FF14794	1/4" NPT Gauge Adapter	3
	FF14796	Union Adapter	2
	FF14798	60" Test Hose Assembly	2
	FF14799	(-) 30 in/Hg - 30 psi Gauge	1
	FF14800	1,000 psi Gauge	1
	FF14801	7,500 psi Gauge	1

## Hose Spacers



Part Number	Description
HSM-48	Case of 48 Mixed Hose Spacers

### Features

- Prevent hose abrasion at points of contact
- Help keep hose organized
- Prevent damage from unrestrained hoses
- Easy to install
- Available in 3/4", 1", 1 1/8", 1 3/8" sizes
- Packed in colorful counter display box of 48, cable ties included
- Also available in mixed box of 48 (12 of each size) or refill bag of 12

## Hose Protectors\*



Part Number	Description
HP4	4" Hose Protector Case of 50
HP6	6" Hose Protector Case of 50
HP8	8" Hose Protector Case of 50
HP10	10" Hose Protector Case of 10
HP12	12" Hose Protector Case of 10
HPM	Mixed Hose Protectors Case of 60

\*Available in black, orange and yellow.

### Abrasion Protection For

- Hydraulic hose
- Battery cables
- Wiring harness
- Brake systems
- Fuel lines
- Air lines
- Radiator hose
- Oil lines

### Features

- Extremely high-wear factor
- Formulated to resist solvents, oils, grease, gasoline, etc.
- 3 grooves protect cable ties and prevent slipping
- Operating temperature range -40° to 430°F
- Exceptionally cost effective
- Easy installation in minutes – no need to remove hose
- Packed in colorful easy-to-assemble, counter display box
- Available in 4", 6" and 8" sizes – cable ties included

### Applications:

- Agriculture
- Industrial
- Trucking
- Mining
- Construction
- Aviation support
- Public transportation
- Road maintenance
- Waste management
- Original equipment manufacturer

## Flaretite® Seals

Flaretite seals are the ideal product to enhance new installations of SAE connections, as well as seal off minor leaks and weeping connections.



### Features

- Ribbed insert design
- Coated with Loctite® sealant
- Economical method to reduce minor leaks and weeping connections
- Built-in clip to attach the Flaretite seal to the nose of the SAE 37° connection
- -04 through -32 sizes

### Benefits

- Multiple surface contact points
- Lock the joint and fill surface imperfections
- Save time and money associated with maintenance and rework
- Quick and easy assembly

**Flaretite Seal**  
Joint Section of Applied Seal

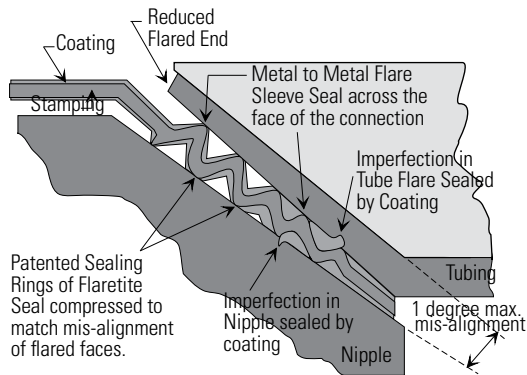

**Standard Flared Connection (Section)**

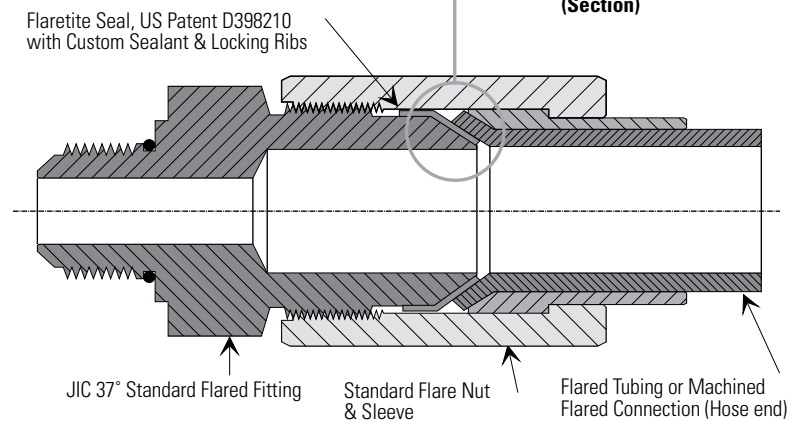

## Assembly and Torque Requirements

To assemble an SAE 37° connection, simply push the Flaretite seal onto the male portion of the connection. The built-in clip will hold the Flaretite seal onto the male half.

- The seal is fitted squarely to the conical nose of the JIC fitting -37° flare
- The sealing faces of the flared connector part are clean and free of burrs
- The flared joint is correctly tightened with recommended torque settings noted below.

During assembly ensure:

\* Flaretite is a registered trademark of Flaretite Inc.

\*\* Loctite is a registered trademark of Henkel Loctite Corporation.

### Note:

All photos and the name Flaretite are the property of Flaretite Inc.

Seal Size	Package Part Number	Number of Seals per Package
-04	FF13267	100
-06	FF13268	100
-08	FF13269	100
-10	FF13270	100
-12	FF13271	100
-16	FF13272	50
-20	FF13273	50
-24	FF13570	25
-32	FF13571	10
Variety Pack	FF14001	6 ea of sizes -04 to -16

### Recommended Torque Settings

#### Tolerance: +10% -0%

-04 (1/4")	SAE 37°: 14lb-ft.	-10 (5/8")	SAE 37°: 80lb-ft.	-20 (1-1/4")	SAE 37°: 190lb-ft.
-06 (3/8")	SAE 37°: 26lb-ft.	-12 (3/4")	SAE 37°: 110lb-ft.	-24 (1-1/2")	SAE 37°: 220lb-ft.
-08 (1/2")	SAE 37°: 55lb-ft.	-16 (1")	SAE 37°: 140lb-ft.	-32 (2")	SAE 37°: 325lb-ft.



## Guardian Sleeve



Eaton's new Guardian Sleeve is designed to provide protection against hydraulic hose failure by containing pressure and fluids that may escape during a hose burst or pinhole leak. With this new line of sight sleeving which meets industry standards, both equipment operators and the environment are guarded from the effects of hose failures.

## Benefits

- Meets new line of sight operator specification EN982 ISO norm 833 EN414 and ISO 3457
- The ultra tight weave resists oil spillage from hose failure
- Meets ASTM D6770 for abrasion resistance of textile webbing
- Meets abrasion standard ISO 6945
- Meets Fed-STD191-Test Method 5309 for abrasion
- Densely twisted polyamide 6 yarn offers optimum UV and abrasion protection
- MSHA approved # IC-234/0 – Meets standard application procedures for acceptance of Flame Resistance Solid Products taken into mines
- Meets Conductivity Requirements of ISO 8031
- Tight, smooth surface resists wear

## Chemical Compatibility Chart for Guardian Sleeving

Chemical	Compatibility
Gasoline	Very Good
Oil	Very Good
Mineral and Vegetable Oil	Very Good
Ionic Metallic Solutions	Very Good
Alcohols	Very Good
Diluted Bases	Very Good
Diluted acids	Good
Benzene	Very Good
Acetone	Very Good
Ether	Very Good
Carbon Tetrachloride	Very Good
Chlorine Based Solvent	Very Good
Mold, Bacteria, Moths	Very Good

\* Strong and concentrated acids; ie. Hcl or Formic Acid may have some corrosive action.

**Denier:** 1260

**Melting Point:** 215°C/420°F

**Material:** Polyamide 6, made with pre-dyed yarn

**Dim. Stability:** Great resistance to sun, atmospheric agents and aging

**Toxicity:** Non-Toxic

**Color:** Black

**Packing Requirements:** Eaton Guardian Sleeve comes in a 300 foot roll with no more than 3 cuts per roll and no piece shorter than 30 feet.

\* Slide sleeve onto the hose before assembling the ends. After assembly, clamp the hose onto the fitting using a metal banding product.

Properties	Specication	Description
Burst Pressure	16,000 psi	Capable to contain hose burst up to 16,000 psi
Pin Hole Leak Pressure	4,000 psi	Sustained 4,000 psi pin hole deflection from focused 1mm pin hole
Abrasion Cycles	250,000	Holds up to 250,000 Abrasion cycles per ISO 6945

## General and Dimensional Information

Part Number	Nominal I.D. (in)	A – Flat Width (in) +/- 0.125	Weights in lbs per 300 ft Roll	Rolls per Box
FF90754-68	0.68	1.290	7.43	8
FF90754-79	0.79	1.400	8.50	7
FF90754-91	0.91	1.590	9.70	6
F90754-98	0.98	1.590	10.13	6
FF90754-106	1.06	1.825	11.10	5
FF90754-122	1.22	2.076	12.60	4
FF90754-142	1.42	2.390	14.50	4
FF90754-157	1.57	2.650	16.10	3
FF90754-173	1.73	2.910	17.70	3
FF90754-185	1.85	3.100	18.80	3
FF90754-209	2.09	3.470	21.10	2
FF90754-219	2.19	3.630	22.10	2
FF90754-238	2.38	3.925	23.90	2
FF90754-288	2.88	4.714	28.60	2
FF90754-366	3.66	5.938	36.10	1

## Guardian Sleeve Selection Chart

Suggested Sleeve Part Number	Sleeve I.D. (in)	Max Hose OD that Sleeve can accept (in)	Hose Size as a Ref.
FF90754-68	0.68	0.52	-4
FF90754-79	0.79	0.61	-4
FF90754-91	0.91	0.70	-6
FF90754-98	0.98	0.76	-6
FF90754-106	1.06	0.80	-6
FF90754-122	1.22	0.92	-8
FF90754-142	1.42	1.02	-10
FF90754-157	1.57	1.13	-10
FF90754-173	1.73	1.24	-12
FF90754-185	1.85	1.34	-16
FF90754-209	2.09	1.50	-16
FF90754-219	2.19	1.54	-20
FF90754-238	2.38	1.70	-20
FF90754-288	2.88	2.00	-20
FF90754-366	3.66	2.40	-24

## Bundling Sleeves

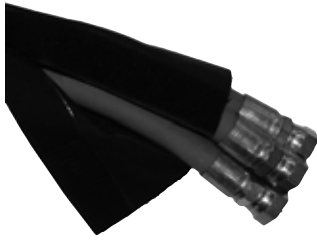

Hydraulic lines are often subjected to tremendous stress and wear during use. Lines that are allowed to move freely are easily abraded, crimped, or cut. Common methods for binding hydraulic lines, such as cable ties, can restrict movement too much as the lines expand and contract.

Bundling sleeves hold lines securely in place to protect them from damage, while providing enough flexibility for normal operation.

The sleeves can be removed and replaced quickly, allowing easy access for hose repair.

### Specifications

Part Number	Fits Bundle Outer Diameter	Circumference of Bundle to be Covered (laid flat)	Sleeve Width	Bulk Roll Length (ft)	Length Tolerance
A4926	2	6.0	7-3/4	150	(+1 ft., - 0 ft)
A4927	3	9.4	11	150	(+1 ft., - 0 ft)
A4928	4	12.5	14	150	(+1 ft., - 0 ft)
A4929	5	15.7	17-1/4	150	(+1 ft., - 0 ft)
A4930	6	18.8	20-3/8	150	(+1 ft., - 0 ft)

### Features

- Tight bundling and secure hose containment
- Resistant to heat, ozone, and abrasion
- Easy removal and replacement

### Benefits

- Increase productivity in assembly and reassembly of hose bundles
- Reduce contamination of hose during bundle assembly
- Force routing of hydraulic lines for safety and efficiency
- Reduce risk of hose bursts, resulting in greater operator safety
- Reduce time spent on field repairs

- Replace inefficient bundling methods and line-damaging cable ties
- Eliminate cumbersome winding of spiral-formed products
- Reduce old-sock-syndrome-bunching at end of bundled lines
- Eliminate line contamination during hose replacement

### Construction

- 1050 ballistit nylon, .71mm thickness
- Urethane coating

**Color**  
Black

### Operating Temperature Range

175° F

### How to order

- Part numbers above are stocked in 150 foot shrink –wrapped bulk rolls, as rolled up and unfastened.
- Orders the number of rolls needed, not footage.
- 150 foot bulk rolls are one continuous length.
- Order per foot

## Bundling Straps



## Merchandising Kits for Straps

### Standard Duty

Part Number FF13502

### Heavy Duty

Part Number FF13503

Contains:

Each merchandising kit comes with a quantity of individually cellophane-wrapped bundling straps in both cinch and hanging styles for bundling diameters of 8", 12", 16", and 20 inches. Resupply the merchandising kit by ordering the individually wrapped straps listed on the next page.

The box has a pop-up lid that can be positioned upright, making an effective advertising backdrop. Attached to the merchandising box is a handy bundling strap for demonstration purposes.

### Note:

Kit boxes are stocked with approximately half the available strap capacity to allow for lower kit pricing at startup.

Bundling straps hold hose, cables, pipes, tubes, and other items securely in place. They can be removed, adjusted, and put back in place easily.

Unlike cable ties, bundling straps allow hose and tubes to expand and contract in changing conditions. Cable ties cannot be reused. Bundling straps, however, can be used again and again, with no loss of strength. Their hook-and-loop fasteners, developed for industrial applications, the safety industry, and the military, have superior sheer strength and peel compared to those used in the garment industry.

### Features

- Easy to remove and replace
- Adjustable to any size bundle
- Industrial strength strap fabric and fasteners
- Secure containment of hose, cables, and other items
- Clean professional appearance

Cinching strap (CS Series) bundling straps are designed for economical service applications, such as hose and cable bundling. All joints are ultrasonically welded and tested.

Hanging strap (HS Series) bundling straps are held in place by a 3/8" grommet. The straps can be mounted vertically or horizontally.

Both cinching and hanging straps are available in standard duty or heavy duty. Heavy-duty bundling straps are designed for severe industrial applications and ultrasonically welded to 1-1/2" hook-and-loop material. All heavy-duty hardware is nickel-plated steel.

### Benefits

- Reduce cost of managing cables and hose
- Improve worker safety and productivity
- Reduce abrasion of bundles items
- Save money through reusability

Bundling straps are sold in packages of five, and discounts are offered for volume quantities of 50, 100, 250, 500, and 1,000. Special sizes, materials, colors, and configurations are available.

### Construction

#### Standard Duty

- 1050 Ballistic nylon II webbing, .71 mm thickness with dense nylon backing
- Delrin plastic fastening loop on cinch and hanging straps
- Urethane coating

#### Heavy Duty

- 1000 Nylon webbing, 3.18 mm thickness with dense nylon backing
- Nickel-plated steel 12 L.14 fastening loop on cinch and hanging straps
- Urethane coating

### Color

- Black

### Operating Temperature Range

- -40° - 250° F





# Accessories



## Bundling Straps

### Cinch Straps Standard Duty

<b>Bulk Packed</b>	<b>Individually Cellophane Wrapped</b>	<b>Heavy Duty Bulk Packed</b>	<b>Individually Cellophane Wrapped</b>	<b>Circumference of Hose Bundle</b>	<b>Strap Length (flat)</b>	<b>Ordering Measurement</b>
<b>Part Number</b>	<b>Part Number</b>	<b>Part Number</b>	<b>Part Number</b>			
FF90519-4	FF90520-4	FF90521-4	FF90522-4	4"	7-3/4"	Each
FF90519-6	FF90520-6	FF90521-6	FF90522-6	6"	11"	Each
FF90519-8	FF90520-8	FF90521-8	FF90522-8	8"	14"	Each
FF90519-10	FF90520-10	FF90521-10	FF90522-10	10"	17-1/4"	Each
FF90519-12	FF90520-12	FF90521-12	FF90522-12	12"	20-3/8"	Each
FF90519-14	FF90520-14	FF90521-14	FF90522-14	14"		Each
FF90519-16	FF90520-16	FF90521-16	FF90522-16	16"		Each
FF90519-18	FF90520-18	FF90521-18	FF90522-18	18"		Each
FF90519-20	FF90520-20	FF90521-20	FF90522-20	20"		Each
	FF90520-22	FF90521-22		22"		Each
	FF90520-24	FF90521-24		24"		Each
	FF90520-26	FF90521-26		26"		Each

### Cinch Straps Standard Duty

<b>Bulk Packed</b>	<b>Individually Cellophane Wrapped</b>	<b>Heavy Duty Bulk Packed</b>	<b>Individually Cellophane Wrapped</b>	<b>Circumference Of Hose Bundle</b>	<b>Strap Length (flat)</b>	<b>Ordering Measurement</b>
<b>Part Number</b>	<b>Part Number</b>	<b>Part Number</b>	<b>Part Number</b>			
FF90523-4	FF90524-4	FF90525-4	FF90526-4	4"	7-3/4"	Each
FF90523-6	FF90524-6	FF90525-6	FF90526-6	6"	11"	Each
FF90523-8	FF90524-8	FF90525-8	FF90526-8	8"	14"	Each
FF90523-10	FF90524-10	FF90525-10	FF90526-10	10"	17-1/4"	Each
FF90523-12	FF90524-12	FF90525-12	FF90526-12	12"	20-3/8"	Each
FF90523-14	FF90524-14	FF90525-14	FF90526-14	14"		Each
FF90523-16	FF90524-16	FF90525-16	FF90526-16	16"		Each
FF90523-18	FF90524-18	FF90525-18	FF90526-18	18"		Each
FF90523-20	FF90524-20	FF90525-20	FF90526-20	20"		Each
		FF90525-22	FF90526-22	22"		Each
		FF90525-24	FF90526-24	24"		Each
		FF90525-26	FF90526-26	26"		Each

# Hose and Gear Clamps

## Hose Support

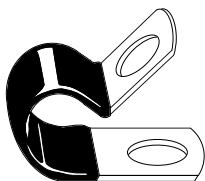

### Application

- Support for long hose length
- Ensure proper hose routing in applications in which abrasion, moving parts, or heat are present

### Construction

- C1010 steel with 1/32" thick black vinyl cushion.
- Zinc-plated

Clamping Diameter	Part Number	Bolt Hole
1/4	HK0509	13/32
3/8	HK0709	13/32
7/16	HK0809	13/32
1/2	HK0913	13/32
9/16	HK1013	13/32
5/8	HK1113	13/32
11/16	HK1213	13/32
3/4	HK1313	13/32
13/16	HK1413	13/32
7/8	HK1513	13/32
15/16	HK1613	13/32
1	HK1713	13/32
1-1/16	HK1813	13/32
1-1/8	HK1913	17/32
1-3/16	HK2017	17/32
1-1/4	HK2117	17/32
1-3/8	HK2317	17/32
1-1/2	HK2517	17/32
1-9/16	HK2617	17/32
1-3/4	HK2917	17/32
1-7/8	HK3117	17/32
1-15/16	HK3217	17/32
2	HK3317	17/32
2-1/8	HK3417	17/32
2-5/8	HK3817	17/32

## E.F.I. Hose Clamps

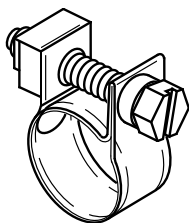

### Application

Electronic fuel injection hose.

### Construction

Plated carbon steel; 23/64" (9mm) band width.

Clamp Size	Part Number	Minimum Diameter	Maximum Diameter	Nominal Diameter
04	6207-004	.433	.551	.512
05	6207-005	.472	.590	.551
06	6207-006	.551	.669	.630

# Hose and Gear Clamps

## Round-Wire Clamps

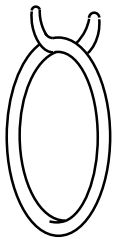

### Application

- Industrial
- Automotive
- Agriculture
- General market applications.

### Construction

- Carbon steel spring wire.
- Zinc-plated

Clamp Size	Hose Size	Part Number	Minimum Diameter	Maximum Diameter	Nominal Diameter
06	1/4	1538	.370	.380	.375
08	5/16	1539	.551	.573	.562
10	3/8	1540	.610	.640	.625

## Heavy-Duty Hose Support Clamps

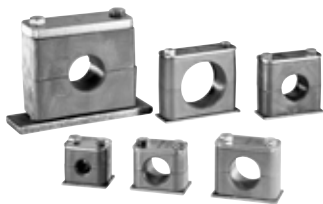

Heavy-duty weld-based clamps are designed to securely hold hose in applications subject to impulsing, flexing, and vibrating conditions. The clamps help prevent abrasion and extend hose life through proper routing. Clamps are rated to ambient temperature of +250°F.

### Part Number FF90311

Clamp Part Number	Inside Diameter (mm)	(in)
FF90311-127	12.70	0.50
FF90311-137	13.70	0.54
FF90311-150	15.00	0.59
FF90311-160	16.00	0.63
FF90311-171	17.10	0.67
FF90311-174	17.40	0.69
FF90311-190	19.00	0.75
FF90311-205	20.50	0.81
FF90311-222	22.20	0.87
FF90311-239	23.90	0.94
FF90311-254	25.40	1.00
FF90311-266	26.60	1.05
FF90311-280	28.00	1.10
FF90311-300	30.00	1.18
FF90311-320	32.00	1.26
FF90311-334	33.40	1.31
FF90311-357	35.70	1.41
FF90311-381	38.10	1.50
FF90311-400	40.00	1.57
FF90311-422	42.20	1.66
FF90311-445	44.50	1.75
FF90311-483	48.30	1.90
FF90311-508	50.80	2.00
FF90311-572	57.20	2.25
FF90311-635	63.50	2.50
FF90311-700	70.00	2.76

# Hose and Gear Clamps

## Full- and Micro-Sized Partial Stainless Steel Clamps SAE J1508 Type F

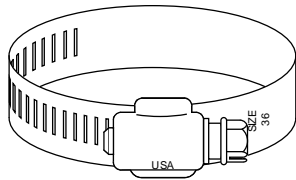

Partial stainless steel clamps utilize a 300 Series stainless steel band and housing with a steel case-hardened, zinc-plated screw. They feature a 14.3mm (9/16") band housing with a 8mm (5/16") hexagon and screwdriver slotted screw.

### Application

- Heavy-duty equipment
- Agriculture
- General industry

## Full- and Micro-Size All Stainless Steel Clamps SAE J1508 Type F

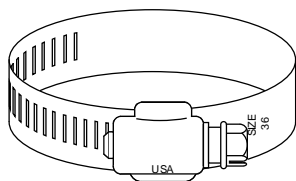

Clamps with an all stainless steel construction offers maximum protection against corrosion. Full-sized all stainless clamps are manufactured with 300 Series stainless steel. They feature a 14.3mm (9/16") band and housing with a 8mm (5/16") hexagon and screwdriver slotted screw.

Micro all stainless clamps have a 5/16" (8mm) band housing manufactured with 300 Series stainless steel.

The 6.35mm (1/4") hexagon and screwdriver slotted screw features 410 stainless steel.

### Application

- Chemical
- Marine
- Food processing
- Dairy
- Automotive
- Electrical
- Plumbing

Clamp Size	Part Number	Minimum Diameter	Maximum Diameter	Nominal Diameter
*004	6205-004	7/32	5/8	1/4
*006	6205-006	5/16	7/8	1/2
006	6203-006	3/8	7/8	1/2
008	6203-008	7/16	1	9/16
010	6203-010	9/16	1-1/16	5/8
012	6203-012	9/16	1-1/4	3/4
016	6203-016	11/16	1-1/2	1
020	6203-020	3/4	1-3/4	1-1/4
024	6203-024	1-1/16	2	1-1/2
028	6203-028	1-5/16	2-1/4	1-3/4
032	6203-032	1-9/16	2-1/2	2
036	6203-036	1-13/16	2-3/4	2-1/4
040	6203-040	2-1/16	3	2-1/2
044	6203-044	2-5/16	3-1/4	2-3/4
048	6203-048	2-9/16	3-1/2	3
052	6203-052	2-13/16	3-3/4	3-1/4
056	6203-056	3-1/16	4	3-1/2
064	6203-064	3-9/16	4-1/2	4
072	6203-072	4-1/16	5	4-1/2
080	6203-080	4-5/8	5-1/2	5
088	6203-088	4-3/32	6	5-1/2
096	6203-096	4-1/2	6-1/2	6
104	6203-104	5	7	6-1/2

\*Micro-sized clamps

Clamp Size	Part Number	Minimum Diameter	Maximum Diameter	Nominal Diameter
*004	6206-004	7/32	5/8	1/4
*006	6206-006	5/16	7/8	1/2
006	6204-006	3/8	7/8	1/2
008	6204-008	7/16	1	9/16
010	6204-010	9/16	1-1/16	5/8
012	6204-012	9/16	1-1/4	3/4
016	6204-016	11/16	1-1/2	1
020	6204-020	3/4	1-3/4	1-1/4
024	6204-024	1-1/16	2	1-1/2
028	6204-028	1-5/16	2-1/4	1-3/4
032	6204-032	1-9/16	2-1/2	2
036	6204-036	1-13/16	2-3/4	2-1/4
040	6204-040	2-1/16	3	2-1/2
044	6204-044	2-5/16	3-1/4	2-3/4
048	6204-048	2-9/16	3-1/2	3
052	6204-052	2-13/16	3-3/4	3-1/4
056	6204-056	3-1/16	4	3-1/2
064	6204-064	3-9/16	4-1/2	4
072	6204-072	4-1/16	5	4-1/2
080	6204-080	4-5/8	5-1/2	5
088	6204-088	4-3/32	6	5-1/2
096	6204-096	4-1/2	6-1/2	6
104	6204-104	5	7	6-1/2

\*Micro-sized clamps